

## Thermo Scientific Accela LC Systems

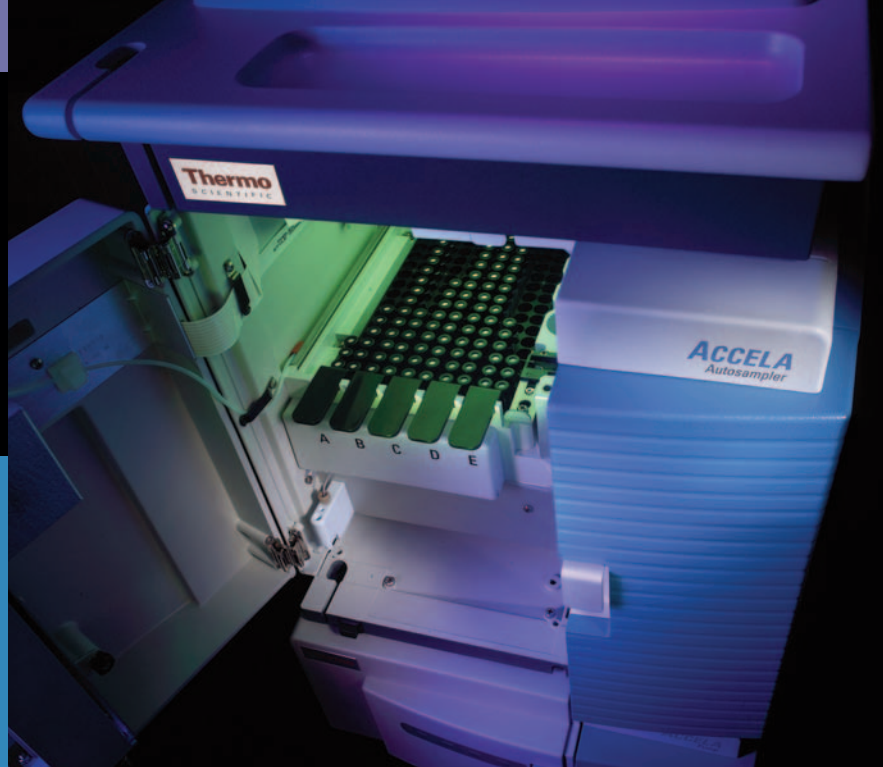

### *Complete Chromatography Solutions No Limits*



Conventional HPLC and UHPLC applications



Unsurpassed ultra high pressure quaternary capabilities



Total temperature management



Extremely low system delay volume



Industry leading LC/MS solution

# Thermo Scientific Accela LC Systems

*Unsurpassed LC capabilities, from HPLC to combined HPLC/UHPLC in one quaternary system with operating pressures up to 1,250 bar.*

Thermo Scientific Accela Systems provide a robust modular system with a large suite of integrated features to increase application flexibility and efficiency, permitting full customization for any laboratory. From routine industrial QA/QC to advanced drug discovery, from traditional HPLC to unsurpassed combined HPLC/UHPLC capabilities in one system, the Accela™ systems are designed for maximum performance, reliability and productivity.

## Pumps

Thermo Scientific Accela Quaternary pumps provide accurate and precise flow and gradients for all HPLC and UHPLC applications. The unique design of the Accela pumps incorporates an innovative Force Feedback Control\* technology that allows the delivery of accurate and precise flow and gradients under all operating conditions by continuously adjusting valve timing and pumping efficiency based on the assessed compressibility of the actual solvents being used thus providing the flexibility of quaternary pumps with the best possible performance. An extremely low pulsation (lower than 0.5 bar amp.) without a pulse dampener guarantees smooth detector baselines.

The Accela 600 pump offers flow rates up to 5 mL/min and a maximum operating pressure of 600 bar with a delay volume of only 90 µL to reduce pump equilibration and system cycle times. The Accela 1250 pump offers a maximum operating pressure of 1,250 bar with a delay volume of only 70 µL.

\* Patent applied for.

## Autosampler

Thermo Scientific Accela Autosampler features temperature-controlled sample trays (for vials or microtiter plates), injection valve, and an integrated column oven to maintain sample integrity before and during analysis. The "Total Temperature Management" system ensures the mobile phase, sample loop, injection valve, and column remain at the same temperature providing maximum retention time reproducibility and minimizing thermal broadening. Method development is easily optimized using one of the multiple injection modes which include full loop, partial loop, and no waste. The Accela systems can also be combined with Open Architecture Autosamplers (HTC and HTS autosamplers) and the Accela Open Autosampler which provides a customizable open frame platform with a stackable design and extremely low carryover.

## Detectors

Thermo Scientific Accela PDA detector provides the highest sensitivity available with our patented Thermo Scientific LightPipe technology. The PDA collects and displays three simultaneous single wavelength channels concurrent with 3-D Spectral data for sample identification and automated purity analysis. The Thermo Scientific Accela UV/Vis Detector combines the economy and reliability of variable wavelength detection with the sensitivity of LightPipe™ technology, with a variety of optional flow cells. The easy-to-use Thermo Scientific Accela Refractive Index Detector is designed specifically for the detection of compounds that have poor absorption in the UV range. The Thermo Scientific MSQ Plus mass detector complements data obtained with other Accela detectors for the rapid identification and mass confirmation of chromatographic peaks. Combine the Accela Systems with the wide range of Thermo Scientific Mass Spectrometers for a complete suite of LC/MS capabilities.

## From HPLC to UHPLC – All in ONE System

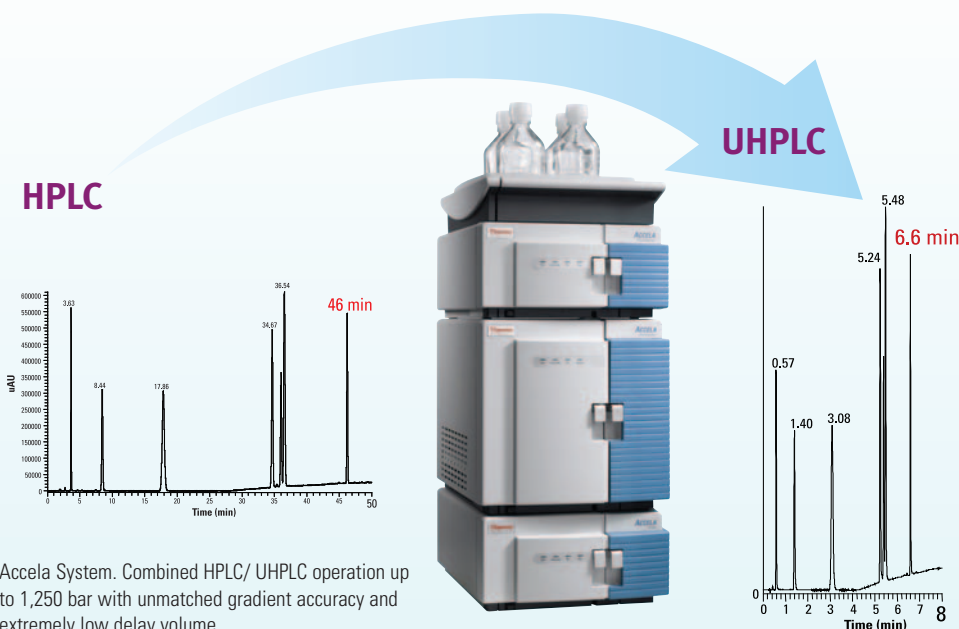

Accela System. Combined HPLC/ UHPLC operation up to 1,250 bar with unmatched gradient accuracy and extremely low delay volume.

## Software

Use our Chromatography or Mass Spectrometry Data Systems such as Thermo Scientific ChromQuest or Xcalibur to fully control Accela for LC or LC/MS applications. These advanced data systems ensure complete control of Accela instrument operation, data acquisition, comprehensive data analysis and reporting. Whether Accela is used as a stand-alone LC or as part of a fully integrated LC/MS system, our comprehensive software solutions provide complete automation and data handling. Other multi vendor software solutions can be used for control and data acquisition when employing Accela as a stand-alone system.

## Maximum sensitivity and resolution for high speed, high throughput applications.

Accela High Speed LC uses Thermo Scientific Hypersil GOLD small particle technology to achieve sharper, narrower chromatographic peaks with increased efficiency and throughput. Our patented LightPipe technology further increases data quality by providing five

times the sensitivity of conventional photodiode array detectors for HPLC applications. The fiber optic beam shaper technology in the Accela PDA collects and focuses the transmitted light from the lightpipe, maximizing spectral resolution without light-reducing slits.

**The Accela High Speed LC system produces fast separations with excellent sensitivity and resolution. Illustrated below, seven phenones elute in less than 1 minute with a Hypersil GOLD™ 1.9 µm column using PDA detection.**

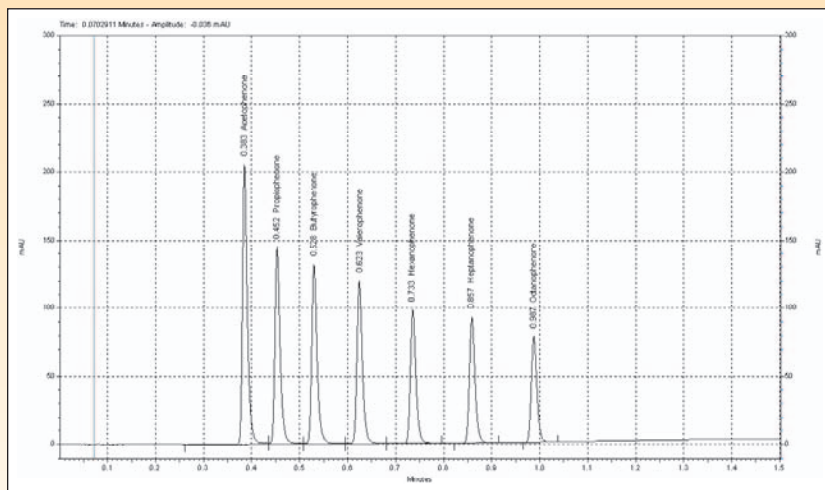

**Column:** Hypersil GOLD 1.9 µm, 100 × 2.1 mm  
**Flow Rate:** 1000 µL/min  
**Mobile Phase:** A–H<sub>2</sub>O; B–CH<sub>3</sub>OH  
**Gradient:**  

<b>Time (min)</b>	<b>%B</b>
0	65
1.0	95
1.5	95

  
**Temperature:** 40 °C  
**Detection:** Photo Diode Array  
**Pressure:** 9,000 psi (620 bar)

Solute	N (plates/m)	Peak width (s)
Acetophenone	72677	1.08
Propiophenone	83369	1.16
Butyrophenone	110000	1.21
Valerophenone	145216	1.24
Hexanophenone	191286	1.26
Heptanophenone	252406	1.30
Octanophenone	334688	1.30

## PDA Detection with Patented LightPipe Technology

The Accela PDA Detector offers up to five times the sensitivity of conventional photodiode array detectors. This is achieved by using our patented LightPipe technology, which provides a 5 cm optical path length at a cell volume of only 10 µL for HPLC applications. For fast UHPLC separations a flow cell of only 2 µL volume (1 cm optical path length) is employed to minimize undesired dispersion. The unique flow path maintains the integrity of the peak shape as it travels through the flow cell to subsequent detectors. Along with unbeatable sensitivity, the fiber optic beam shaper in the Accela PDA offers absorbance measurements with excellent spectral resolution and increased throughput over the entire wavelength range of 190 – 800 nm. The pre-aligned deuterium and tungsten lamps ensure high spectral intensities for high signal-to-noise absorbance measurements, while the high data rate of 80 Hz at 1 nm wavelength increments provides excellent spectral and time resolution for fast chromatography and high-speed HTS (High Throughput Screening) applications. The Accela Plus ensures wavelength accuracy with an integrated filter cuvette filled with a certified holmium oxide solution for calibration over the entire UV-Visible spectrum.

**Patented LightPipe technology provides up to 5x the detection sensitivity of a conventional PDA detector.**

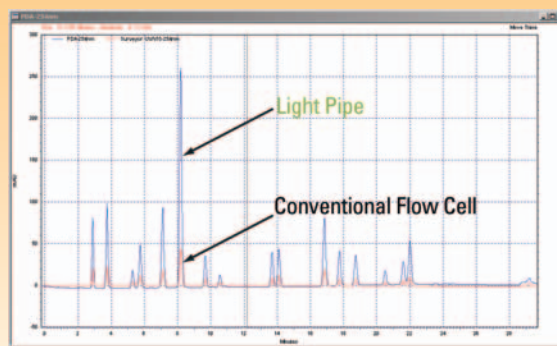

## Accela Pumps

*The world's most accurate and precise HPLC and UHPLC pumps.*

Unique and innovative Force Feedback Control (FFC) technology enables the delivery of accurate and precise flow and gradients under all operating conditions by continuously adjusting valve timing and pumping efficiency based on the measured compressibility of the actual solvents providing the flexibility of a quaternary pump with unparalleled performance.

- **Accela 600 pump: flow rate up to 5 mL/min and a maximum operating pressure of 600 bar.**
- **Accela 1250 pump: maximum flow rate of 2 mL/min and a maximum operating pressure of 1,250 bar.**

### Accela Pumps Advantages

- **Quaternary capability.** Benefit: flexibility for method development and multi-method operation, possibility to carry out complex separations employing ternary and quaternary gradients.
- **Extremely low delay volume.** Benefit: enables fast gradients, which translates into shorter run times and therefore higher throughput and faster method development.
- **Equipped with sensors for adjusting valve timing and pumping efficiency that are not in contact with the mobile phase.** Benefit: stable baselines, greatest flow and gradient accuracy, no problems with sensor response variations over time due to contact with mobile phase.
- **Flow accuracy equal or better than  $\pm 0.5\%$  for the entire pressure and flow rate operating range of the pump.** Benefit: performance not compromised due to different run conditions; enhanced run-to-run reproducibility.
- **Gradient accuracy equal or better than  $\pm 0.5\%$  for the entire pressure and flow rate operating range of the pump.** Benefit: performance not compromised due to different flow or pressure conditions; enhanced run-to-run reproducibility.
- **Pump pulsation lower than 0.5 bar without the need of a pulse dampener.** Benefit: lowest pulsation over entire range for smooth baselines which translates into enhanced detection.

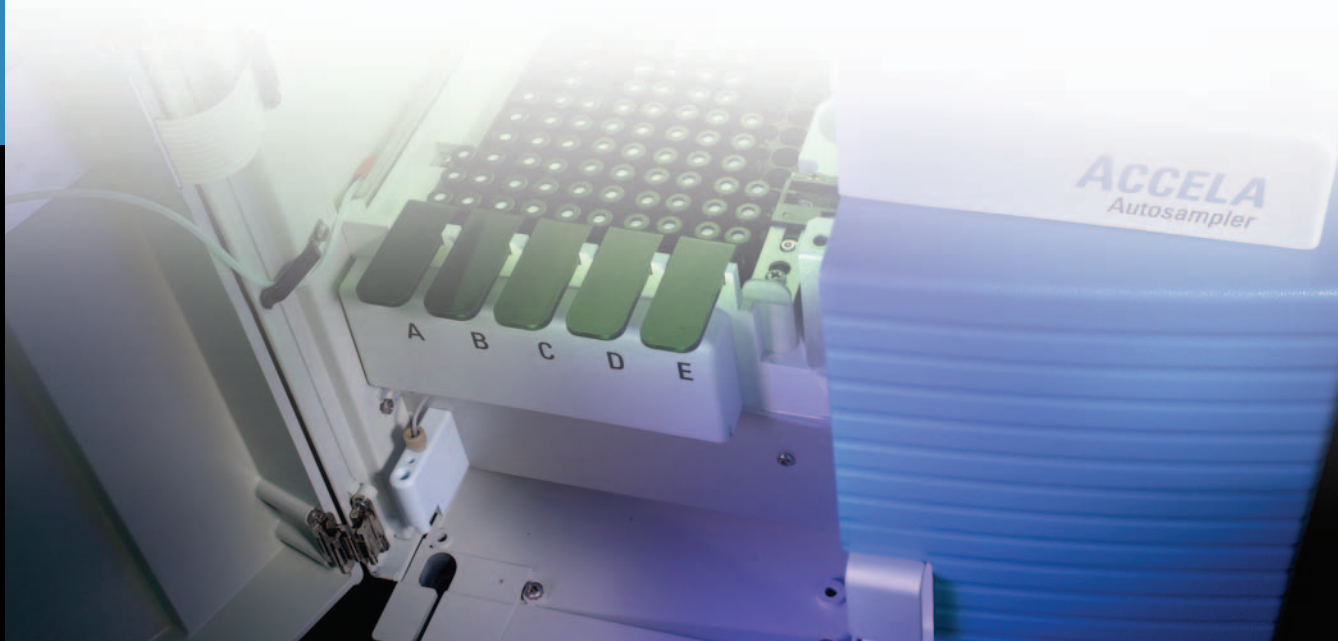

## Stable and rapid solvent delivery for all HPLC and UHPLC applications.

Force Feedback Control removes the need for a pulse dampener enabling the Accela pumps to form accurate gradients virtually pulsation free.

### Force Feedback Control Benefits

- **Accurate flow at any pressure**
- **Accurate gradient formation at all operating conditions**
- **Stable baselines with no pulse dampener**

Force Feedback Control provides constant and accurate volumetric flow rate independent from backpressure or actual solvent composition.

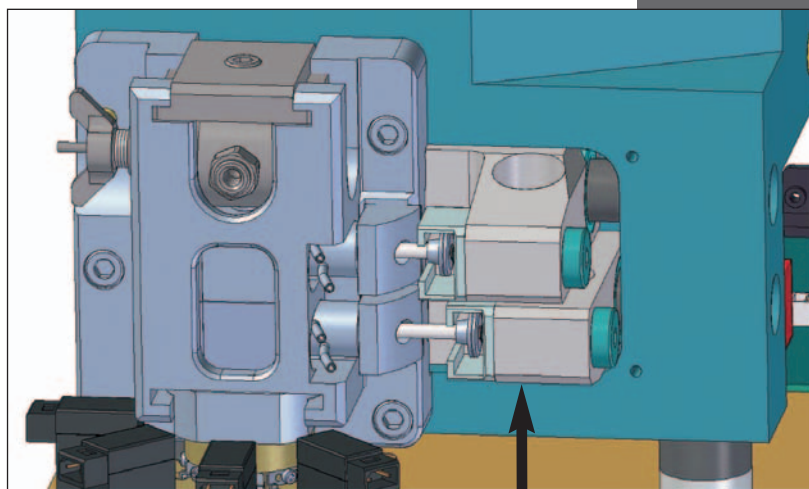

Z-arm with force sensor

### Flow Rate Deviation at Setpoint (Water)

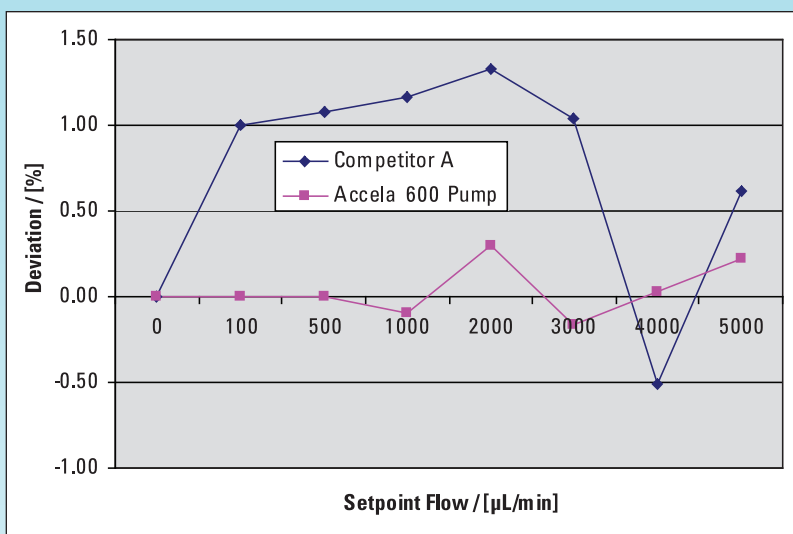

Comparison of flow rate deviation (left panel) and residual pulsation (bottom panel) obtained with the Thermo Scientific Accela 600 pump and those obtained with a competitor's pump.

### Residual Pulsation (CH<sub>3</sub>CN)

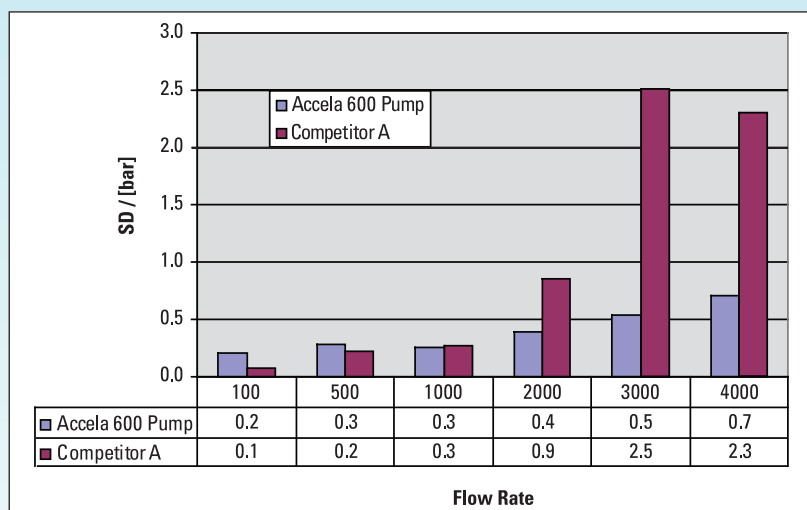

## The Fastest LC Meets the Fastest Ion Trap

*Accelerating the capabilities of the world's fastest ion traps with reduced run times and increased sensitivity.*

- **Accela maximizes metabolic application flexibility by accommodating the backpressures of many different column lengths**
- **Industry leading MS/MS cycle speed provides more data in less time**
- **Intelligent precursor ion selection with automated Data Dependent MS<sup>n</sup> provides data on targeted and unpredicted analytes**

The Accela System routinely provides peak widths of one second and shorter (FWHH), which challenges the scan speeds and duty cycles of many mass spectrometers. Our industry-leading ion trap mass spectrometry technology provides maximum data for even the sharpest chromatographic peaks without compromising data quality.

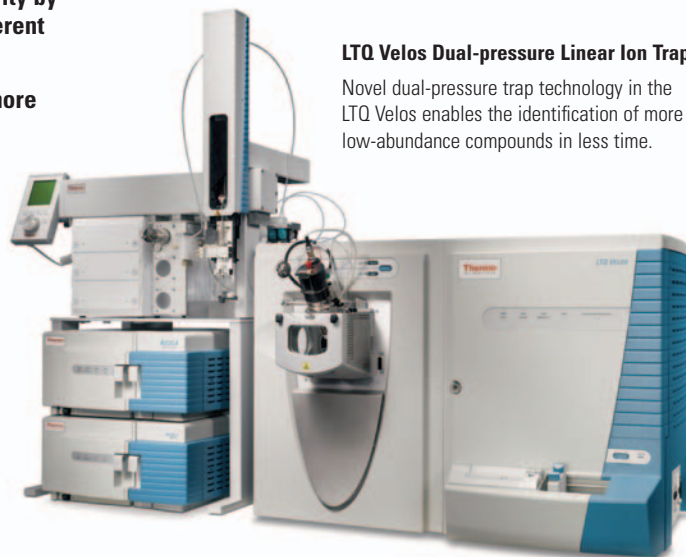

### LTQ Velos Dual-pressure Linear Ion Trap

Novel dual-pressure trap technology in the LTQ Velos enables the identification of more low-abundance compounds in less time.

### Thermo Scientific LTQ Velos

**With new S-Lens ion guide technology, a revolutionary dual-pressure linear ion trap, and predictive automatic gain control, the LTQ Velos™ is the fastest, most-sensitive ion trap available today. It enables the identification and quantification of low-abundance compounds in half the time, providing confidence in every result.**

### Thermo Scientific LTQ XL

**The LTQ XL™ combines exceptional sensitivity with tremendous flexibility. Multiple dissociation techniques as well as MALDI and ETD add-ons enable the generation of extensive structural information for challenging proteomics and metabolism applications.**

### Thermo Scientific LCQ Fleet

**The LCQ Fleet™ ion trap makes excellent full-scan MS<sup>n</sup> sensitivity, ruggedness, and reliability cost effective. It delivers rich information for routine analysis of complex samples and integrates seamlessly with fast HPLC systems under an easy-to-use single point of control.**

### *Optimize the efficiency of MS<sup>n</sup> identification.*

Accela is designed to optimize the efficiency of separation in the column regardless of column length. Whether short columns for targeted analysis, or long columns for complex mixtures, Accela easily handles the resulting backpressure, allowing you to work at optimal column flow rates using a variety of column lengths. Coupling Accela to a linear ion trap mass spectrometer provides fast, accurate MS<sup>n</sup> data of the most complex metabolic compounds and products.



# High Speed Separations with Enhanced Quantitation

*Accela, coupled to Thermo Scientific quadrupole mass spectrometers, provides sensitivity, specificity, and speed in quantitation.*

The exceptional separation efficiency of Accela with Hypersil GOLD columns greatly enhances both speed and sensitivity of quantitation for high throughput analysis. The high chromatographic efficiencies of 1.9  $\mu\text{m}$  Hypersil GOLD columns focus peaks into narrow bands providing enhanced signal to noise. Additionally, by separating the analyte from the matrix, charge competition in the API source is reduced, increasing ionization efficiency, resulting in increased sensitivity.



The Thermo Scientific TSQ Quantum Access MAX triple stage quadrupole mass spectrometer analyzes up to 300 SRMs per second, rapidly identifying and quantitating even the most complex mixtures.

The Thermo Scientific TSQ Vantage triple stage quadrupole mass spectrometer delivers the highest sensitivity with the lowest chemical noise.

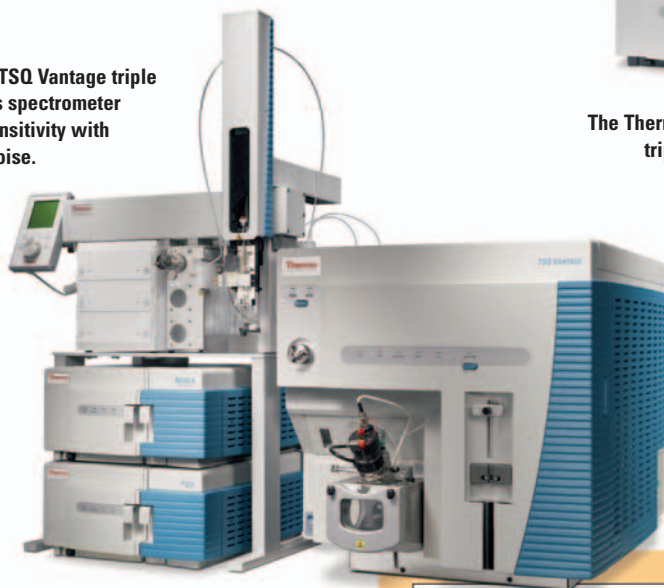

The MSQ Plus™ single quadrupole mass detector has scan speeds up to 12,000 Da/sec, offering quick and clear mass identification for even the fastest chromatographic peaks.

The bottom chromatogram shows increased LC/MS sensitivity through chromatographic focusing of the peak compared to the original top chromatogram.

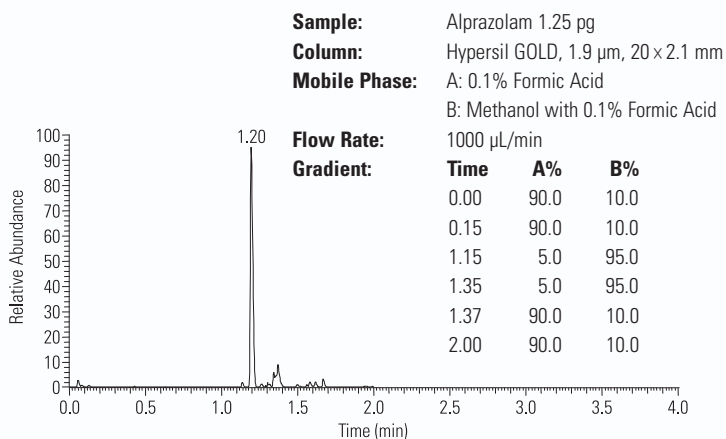
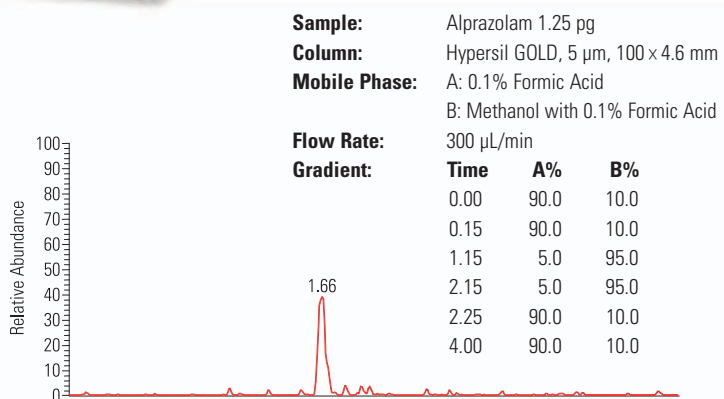

## High Resolution with Accurate Mass

*High speed chromatography provides an additional degree of separation to the Thermo Scientific Orbitrap-based mass spectrometers with the benefit of sharp chromatography enhancing the dynamic range of even the most complex separations.*



### **Thermo Scientific Exactive – A new era in high-resolution benchtop mass spectrometry**

The easy-to-use Exactive™ LC/MS system delivers accurate mass for every scan without the need for data averaging. Operating at a 10 Hz scanning frequency, Exactive is fully compatible with UHPLC and ensures exact mass measurement for fast chromatography applications.

### **Thermo Scientific LTQ Orbitrap Velos – Ultimate Confidence**

Combining the LTQ Velos with industry leading Orbitrap™ technology, the LTQ Orbitrap Velos™ provides the next level of performance for your research. The high mass accuracy of the LTQ Orbitrap Velos increases the speed and confidence of identification in complex samples by minimizing false positive identification.



## High speed chromatography combined with high resolution accurate mass MS.

The inherent complexity of metabolic mixtures employs chromatographic and accurate mass separation techniques to provide structural information of individual components. The broad range of chemistries often requires multiple injections with different chromatographic or ionization conditions using long columns to achieve adequate separation, taking hours to complete. By coupling the Accela System with the LTQ Orbitrap™ series and Exactive mass spectrometers fast separations are easily achieved on long columns providing sharper peaks while greatly reducing run times.



### Conventional LC/MS in 33 minutes

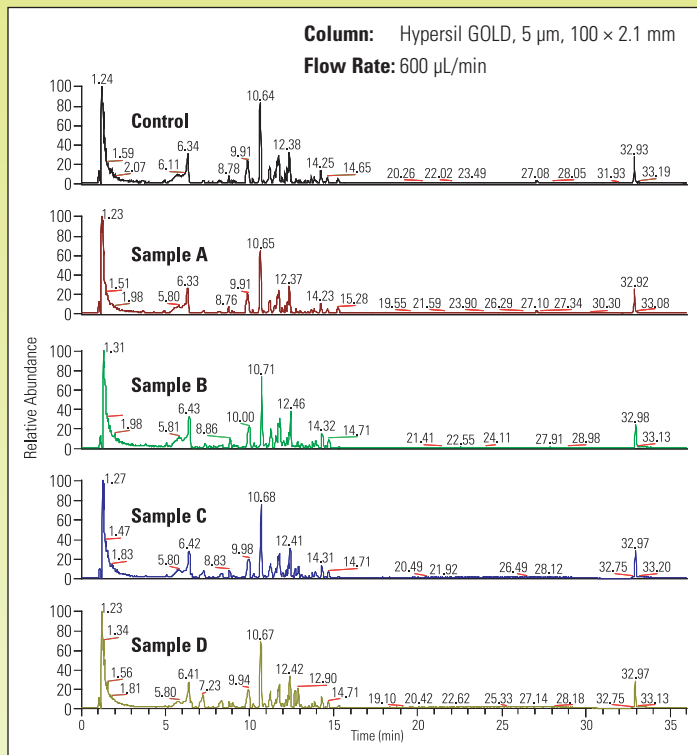

When the LTQ Orbitrap is coupled with the Accela LC and a 1.9  $\mu$ m Hypersil GOLD column, the run time is reduced by 20 minutes (from 33 to 13 minutes), providing a time savings with increased sensitivity and resolution.

In the analysis below, four urine samples were spiked with a drug mixture of primidones, opiates, and amphetamines.

### High Speed LC/MS in 13 minutes

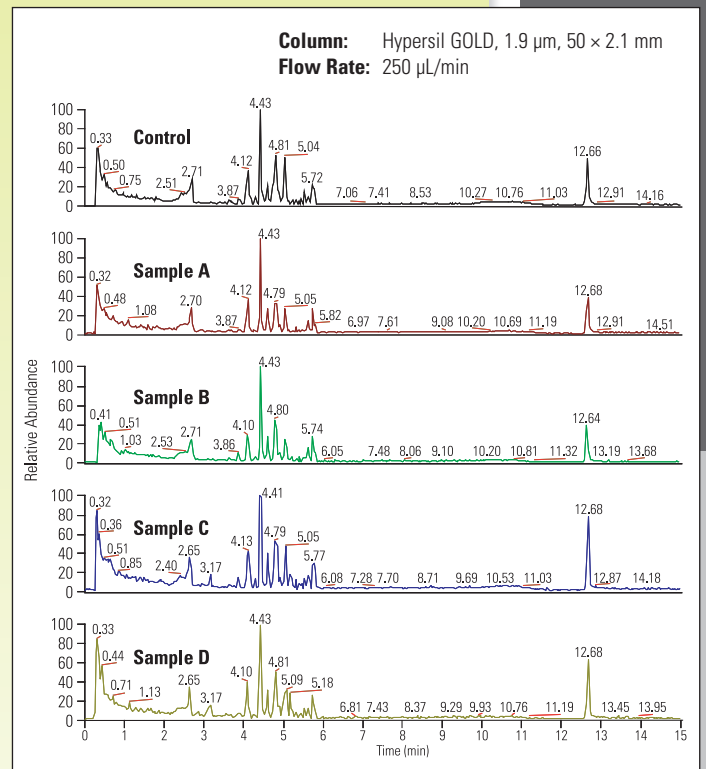

## Best Separations for any HPLC, UHPLC, HPLC/MS or UHPLC/MS Application with Hypersil GOLD Columns

*Maximize separation efficiency with the ability to select the ideal column for your application.*



Hypersil GOLD columns utilize the very latest in highly pure silica technology, along with a new novel proprietary bonding and end-capping procedure. The new bonding and end-capping delivers outstanding peak shapes for basic analyte types leading to increased sensitivity of analysis, improved resolution between critical pairings, and enhanced throughput. The outstanding peak shapes provided by the new bonding technology increases confidence in the stationary phase. This provides enhanced resolution and resolves impurities from the parent ion due to increased peak heights, which allows accurate qualitative and quantitative data. Hypersil columns are available in a variety of particle sizes from the all-new 1.9 and 2.4  $\mu\text{m}$  particles to more traditional sizes 3, 5, 8, and 12  $\mu\text{m}$  particles spanning the spectrum of requirements from capillary and HTS to preparative scale.

Accela hyperbaric LC is designed to work from conventional to ultra-high pressures, maximizing the advantage of the superior efficiency and peak shape of the Hypersil GOLD column regardless of length. High speed separations of relatively simple mixtures using ballistic gradients are easily achieved using shorter columns. These columns generate very low backpressures easily handled by Accela.

More complex separations like those often found in metabolite and biomarker analysis require longer columns for efficient separation of thousands of compounds. These columns generate high backpressures that are just as easily handled by Accela.

Accela is designed to provide optimum performance from the column, period. Forget about the pressure. Select the ideal column for your analytical challenge and maximize the efficiency with Accela.

**Hypersil GOLD 1.9  $\mu\text{m}$  columns are available in a variety of lengths, diameters, and selectivities.**

**For a complete list, contact your local Thermo Scientific product representatives or visit [www.thermo.com/columns](http://www.thermo.com/columns)**



**Hypersil GOLD 1.9  $\mu\text{m}$  columns allow high flow rates without loss of efficiency. The figure below shows how column length and particle size can be optimized to reduce run time while maintaining maximum efficiency.**

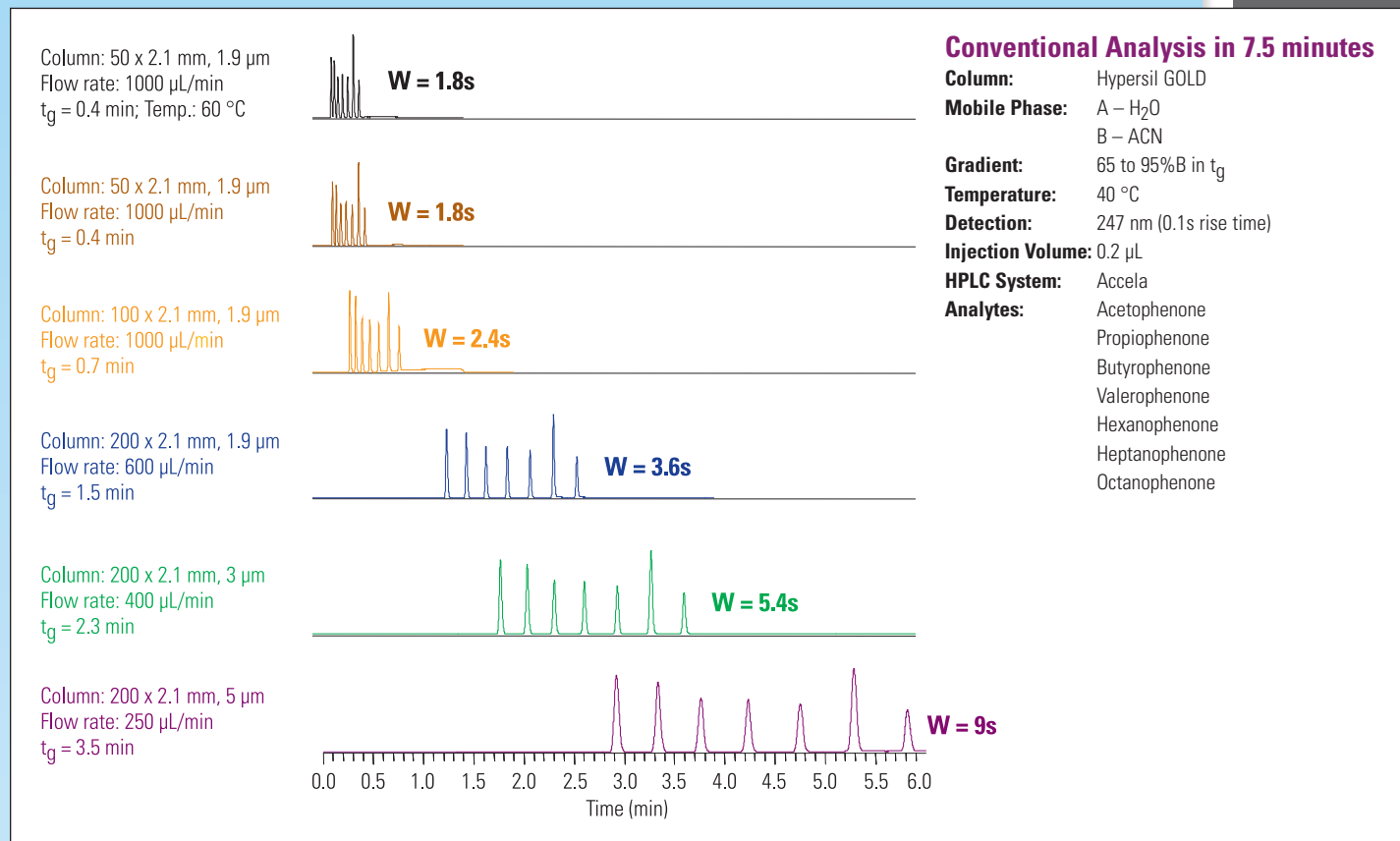

**This figure illustrates the optimum flow rate for a given particle size providing highest efficiency with the resultant effect on back-pressure using a 50 x 2.1 mm Hypersil GOLD column.**

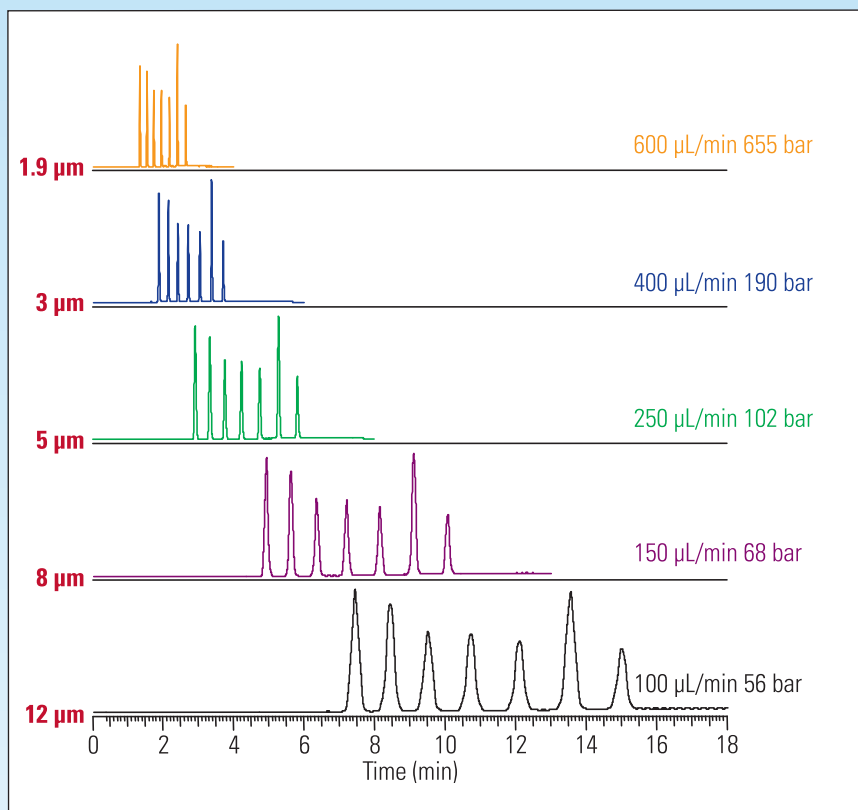

## Laboratory Solutions Backed by Worldwide Service and Support

Tap our expertise throughout the life of your instrument. Thermo Scientific Services extends its support throughout our worldwide network of highly trained and certified engineers who are experts in laboratory technologies and applications. Put our team of experts to work for you in a range of disciplines – from system installation, training and technical support, to complete asset management and regulatory compliance consulting. Improve your productivity and lower the cost of instrument ownership through our product support services. Maximize uptime while eliminating the uncontrollable cost of unplanned maintenance and repairs. When it's time to enhance your system, we also offer certified parts and a range of accessories and consumables suited to your application.

To learn more about our products and comprehensive service offerings, visit us at [www.thermo.com](http://www.thermo.com).



In addition to these offices, Thermo Fisher Scientific maintains a network of representative organizations throughout the world.

### **Africa-Other**

+27 11 570 1840 • [analyze.sa@thermo.com](mailto:analyze.sa@thermo.com)

### **Australia**

+61 2 8844 9500 • [analyze.au@thermo.com](mailto:analyze.au@thermo.com)

### **Austria**

+43 1 333 50 34 0 • [analyze.at@thermo.com](mailto:analyze.at@thermo.com)

### **Belgium**

+32 53 73 42 41 • [analyze.be@thermo.com](mailto:analyze.be@thermo.com)

### **Canada**

+1 800 530 8447 • [analyze.ca@thermo.com](mailto:analyze.ca@thermo.com)

### **China**

+86 10 8419 3588 • [analyze.cn@thermo.com](mailto:analyze.cn@thermo.com)

### **Denmark**

+45 70 23 62 60 • [analyze.dk@thermo.com](mailto:analyze.dk@thermo.com)

### **Europe - Other**

+43 1 333 50 34 0 • [analyze.emea@thermo.com](mailto:analyze.emea@thermo.com)

### **Finland / Norway / Sweden**

+46 8 556 468 00 • [analyze.se@thermo.com](mailto:analyze.se@thermo.com)

### **France**

+33 1 60 92 48 00 • [analyze.fr@thermo.com](mailto:analyze.fr@thermo.com)

### **Germany**

+49 6103 408 1014 • [analyze.de@thermo.com](mailto:analyze.de@thermo.com)

### **India**

+91 22 6742 9434 • [analyze.in@thermo.com](mailto:analyze.in@thermo.com)

### **Italy**

+39 02 950 591 • [analyze.it@thermo.com](mailto:analyze.it@thermo.com)

### **Japan**

+81 45 453 9100 • [analyze.jp@thermo.com](mailto:analyze.jp@thermo.com)

### **Latin America**

+1 608 276 5659 • [analyze.la@thermo.com](mailto:analyze.la@thermo.com)

### **Middle East**

+43 1 333 50 34 0 • [analyze.emea@thermo.com](mailto:analyze.emea@thermo.com)

### **Netherlands**

+31 76 579 55 55 • [analyze.nl@thermo.com](mailto:analyze.nl@thermo.com)

### **South Africa**

+27 11 570 1840 • [analyze.sa@thermo.com](mailto:analyze.sa@thermo.com)

### **Spain**

+34 914 845 965 • [analyze.es@thermo.com](mailto:analyze.es@thermo.com)

### **Switzerland**

+41 61 716 77 00 • [analyze.ch@thermo.com](mailto:analyze.ch@thermo.com)

### **UK**

+44 1442 233555 • [analyze.uk@thermo.com](mailto:analyze.uk@thermo.com)

### **USA**

+1 800 532 4752 • [analyze.us@thermo.com](mailto:analyze.us@thermo.com)

[www.thermo.com](http://www.thermo.com)



Thermo Fisher Scientific, Austin, TX USA is ISO Certified.

©2009-2010 Thermo Fisher Scientific Inc. All rights reserved. All trademarks are the property of Thermo Fisher Scientific Inc. and its subsidiaries.

Specifications, terms and pricing are subject to change. Not all products are available in all countries. Please consult your local sales representative for details.

BR62336\_E 03/10M

**Thermo**  
SCIENTIFIC